

**DAIKIN**



# **OPERATION MANUAL**

## **VRV IV-S system air conditioner**

**RXYSQ6TAV1B**

RXYSQ

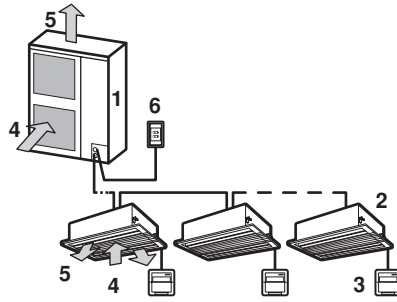

1

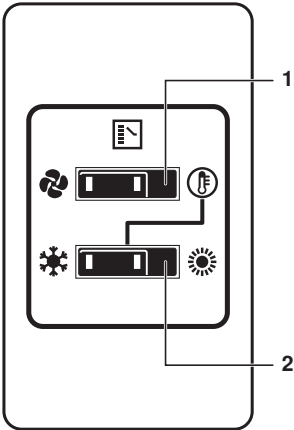

2

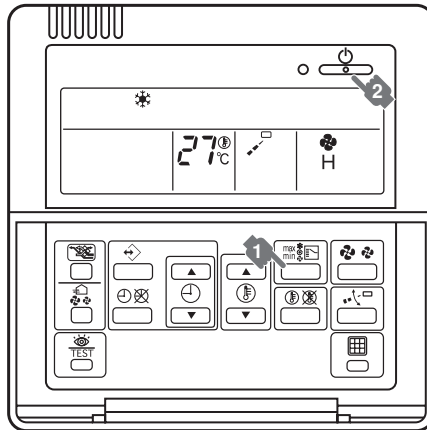

3

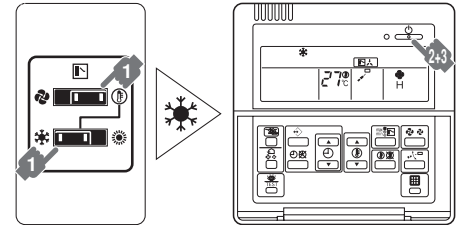

4.1

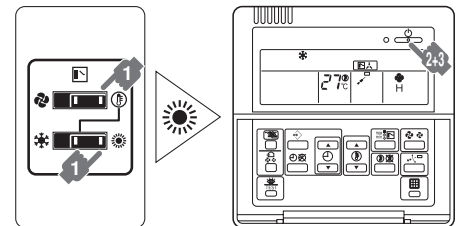

4.2

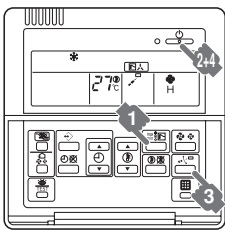

5

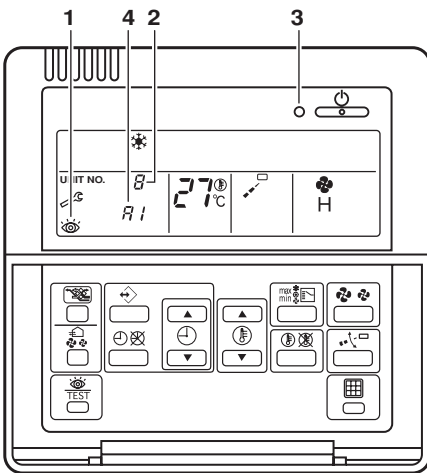

7

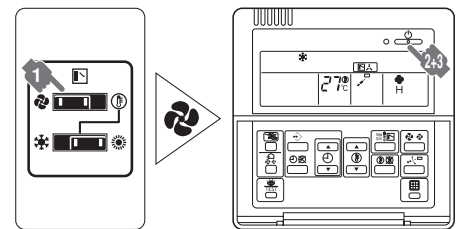

4.3

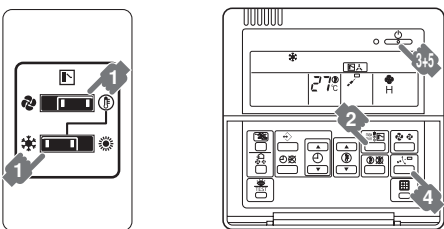

6

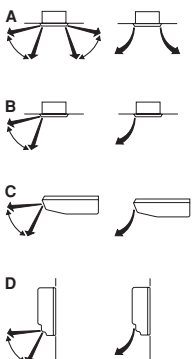

8

RXYSQ

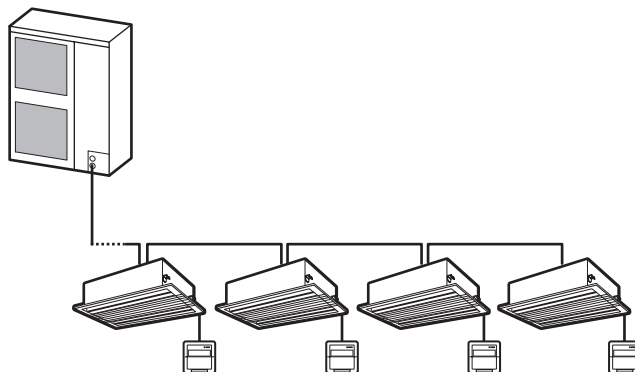

9

**CONTENTS**

	Page
1. Safety cautions .....	1
2. Important information regarding the refrigerant used .....	2
3. What to do before operation .....	3
4. Remote controller.....	3
5. Changeover switch: Name and function of each switch.....	3
6. Operation range .....	3
7. Operation procedure .....	3
7.1. Cooling, heating, fan only, and automatic operation .....	3
7.2. Program dry operation .....	4
7.3. Adjusting the air flow direction .....	5
7.4. Setting the master remote controller.....	5
7.5. Precautions for group control system or two remote controller control system.....	5
8. Energy saving and optimum operation .....	6
9. Maintenance .....	6
9.1. Maintenance after a long stop period.....	6
9.2. Maintenance before a long stop period.....	6
10. Following symptoms are not air conditioner troubles .....	6
11. Troubleshooting.....	7
12. After-sales service and warranty.....	8
12.1. After-sales service .....	8
12.2. Shortening of "maintenance cycle" and "replacement cycle" needs to be considered in following situations.....	9



Thank you for purchasing this Daikin air conditioner. Carefully read this operation manual before using the air conditioner. It will tell you how to use the unit properly and help you if any trouble occurs. After reading the manual, file it away for future reference.

The original instructions are written in English. All other languages are translations of the original instructions.

**1. SAFETY CAUTIONS**

Read the following cautions carefully and use your equipment properly.



**WARNING**

Improper handling can lead to such serious consequences as death, severe injury or damage to the equipment.

**NOTE**



These instructions will ensure proper use of the equipment.

Be sure to follow these important safety cautions.

Keep these warning sheets handy so that you can refer to them if needed.

Also, if this equipment is transferred to a new user, make sure to hand over this user's manual to the new user.

**Warnings**

- It is not good for your health to expose your body to the air flow for a long time.
- In order to avoid electric shock, fire or injury, or if you detect any abnormality such as smell of fire, turn off the power supply and call your dealer for instructions.
- Ask your dealer for installation of the air conditioner. Incomplete installation performed by yourself may result in a water leakage, electric shock, and fire.
- Do not place objects in direct proximity of the outdoor unit and do not let leaves and other debris accumulate around the unit. Leaves are a hotbed for small animals which can enter the unit. Once in the unit, such animals can cause malfunctions, smoke or fire when making contact with electrical parts.
- Ask your dealer for improvement, repair, and maintenance. Incomplete improvement, repair, and maintenance may result in a water leakage, electric shock and fire.
- Do not insert fingers, rods or other objects into the air inlet or outlet. When the fan is rotating at high speed, it will cause injury.
- Never let the indoor unit or the remote controller get wet. It may cause an electric shock or a fire.
- Never use a flammable spray such as hair spray, lacquer or paint near the unit. It may cause a fire.
- Never touch the air outlet or the horizontal blades while the swing flap is in operation. Fingers may become caught or the unit may break down.
- Never replace a fuse with that of wrong ampere ratings or other wires when a fuse blows out. Use of wire or copper wire may cause the unit to break down or cause a fire.
- Never put any objects into the air inlet or outlet. Objects touching the fan at high operating speed can be dangerous.
- Never press the button of the remote controller with a hard, pointed object. The remote controller may be damaged.
- Never pull or twist the electric wire of the remote controller. It may cause the unit to malfunction.
- Never inspect or service the unit by yourself. Ask a qualified service person to perform this work.
- To prevent refrigerant leak, contact your dealer. When the system is installed and runs in a small room, it is required to keep the concentration of the refrigerant, if by any chance coming out, below the limit. Otherwise, oxygen in the room may be affected, resulting in a serious accident.
- The refrigerant in the air conditioner is safe and normally does not leak. If the refrigerant leaks in the room, contact with a fire of a burner, a heater or a cooker may result in a harmful gas. Turn off any combustible heating devices, ventilate the room and contact the dealer where you purchased the unit. Do not use the air conditioner until a service person confirms that the portion where the refrigerant leaks is repaired.
- Improper installation or attachment of equipment or accessories could result in electric shock, short-circuit, leaks, fire or other damage to the equipment. Be sure to use only accessories made by Daikin which are specifically designed for use with the equipment and have them installed by a professional.
- Ask your dealer to move and reinstall the air conditioner. Incomplete installation may result in a water leakage, electric shock, and fire.

## Cautions

- Do not use the air conditioner for other purposes.  
In order to avoid any quality deterioration, do not use the unit for cooling precision instruments, food, plants, animals or works of art.
- In order to avoid injury, do not remove the fan guard of the outdoor unit.
- To avoid oxygen deficiency, ventilate the room sufficiently if equipment with burner is used together with the air conditioner.
- After a long use, check the unit stand and fitting for damage.  
If damaged, the unit may fall and result in injury.
- Do not place a flammable spray bottle near the air conditioner and do not use sprays.  
Doing so may result in a fire.
- Before cleaning, be sure to stop the operation, turn the breaker off or pull out the supply cord.  
Otherwise, an electric shock and injury may result.
- Do not operate the air conditioner with a wet hand.  
An electric shock may result.
- Do not place items which might be damaged by moisture under the indoor unit.  
Condensation may form if the humidity is above 80%, if the drain outlet is blocked or the filter is polluted.
- Do not place appliances which produce open fire in places exposed to the air flow from the unit or under the indoor unit. It may cause incomplete combustion or deformation of the unit due to the heat.
- Do not allow anyone to mount on the outdoor unit or avoid placing any object on it.  
Falling or tumbling may result in injury.
- Never expose little children, plants or animals directly to the air flow.  
Adverse influence to little children, animals and plants may result.
- Do not wash the air conditioner with water.  
Electric shock or fire may result.
- This appliance is not intended for use by persons, including children, with reduced physical, sensory or mental capabilities, or lack of experience and knowledge, unless they have been given supervision or instruction concerning use of the appliance by a person responsible for their safety.
- Do not install the air conditioner at any place where flammable gas may leak out.  
If the gas leaks out and stays around the air conditioner, a fire may break out.
- In order to avoid electric shock or fire, make sure that an earth leak detector is installed.
- Be sure the air conditioner is electrically earthed.  
In order to avoid electric shock, make sure that the unit is grounded and that the earth wire is not connected to gas or water pipe, lightning conductor or telephone earth wire.
- Arrange the drain hose to ensure smooth drainage. Incomplete drainage may cause wetting of the building, furniture etc.
- Do not let children play on and around the outdoor unit.  
If they touch the unit carelessly, it may result in injury.
- Do not place a flower vase or anything containing water on the unit.  
Water may enter the unit, causing an electric shock or fire.
- Do not place the controller exposed to direct sunlight.  
The LCD display may get discolored, failing to display the data.
- Do not wipe the controller operation panel with benzine, thinner, chemical dustcloth, etc.  
The panel may get discolored or the coating peeled off. If it is heavily dirty, soak a cloth in water-diluted neutral detergent, squeeze it well and wipe the panel clean. Wipe it with another dry cloth.

- Never touch the internal parts of the controller.  
Do not remove the front panel. Some parts inside are dangerous to touch and a machine trouble may happen. For checking and adjusting the internal parts, contact your dealer.
- Avoid placing the controller in a spot splashed with water.  
Water coming inside the machine may cause an electric leak or may damage the internal electronic parts.
- Do not operate the air conditioner when using a room fumigation-type insecticide.  
Failure to observe could cause the chemicals to become deposited in the unit, which could endanger the health of those who are hypersensitive to chemicals.
- Do not touch the heat exchanger fins.  
These fins are sharp and could result in cutting injuries.
- The appliance is not intended for use by young children or infirm persons without supervision.
- Young children should be supervised to ensure that they do not play with the appliance.

## 2. IMPORTANT INFORMATION REGARDING THE REFRIGERANT USED

This product contains fluorinated greenhouse gases. Do not vent gases into the atmosphere.

Refrigerant type: R410A  
GWP<sup>(1)</sup> value: 2087.5

<sup>(1)</sup> GWP = global warming potential

Periodical inspections for refrigerant leaks may be required depending on European or local legislation. Please contact your local dealer for more information.

### 3. WHAT TO DO BEFORE OPERATION

This operation manual is for the following systems with standard control. Before initiating operation, contact your dealer for the operation that corresponds to your system type and mark.

If your installation has a customized control system, ask your dealer for the operation that corresponds to your system.

For the RXYRQ outdoor series, if the indoor unit is SA or RA, then refer to the operation manual included with the indoor unit for more information.

Outdoor units (See figure 1)



Names and functions of parts (See figure 1)

- 1 Outdoor unit
- 2 Indoor unit
- 3 Remote controller
- 4 Inlet air
- 5 Outlet air
- 6 Cool/heat changeover remote control switch
- 7 BS (branch selector) unit

(figure 1 shows systems with changeover remote control switches.)

### 4. REMOTE CONTROLLER

Refer to the operation manual of the remote controller.

### 5. CHANGEOVER SWITCH: NAME AND FUNCTION OF EACH SWITCH (See figure 2)

- 1 FAN ONLY/AIR CONDITIONING SELECTOR SWITCH  
Set the switch to for fan only operation or to for heating or cooling operation.
- 2 COOL/HEAT CHANGEOVER SWITCH  
Set the switch to for cooling or to for heating operation.

### 6. OPERATION RANGE

#### Operation range

Use the system in the following temperature and humidity ranges for safe and effective operation.

RXYSQ6TA		
Outdoor temperature	-5~46°C DB	-20~24°C DB <sup>(*)</sup> -20~15.5°C WB
Indoor temperature	21~32°C DB 14~25°C WB	15~27°C DB
Indoor humidity	≤80% <sup>(†)</sup>	

(\*) Range for operation: -20~-15°C WB. Range for continuous operation: -15~-15.5°C WB.

(†) to avoid condensation and water dripping out the unit. If the temperature or the humidity is beyond these conditions, safety devices may work and the air conditioner may not operate.

### 7. OPERATION PROCEDURE

- Operation procedure varies according to the combination of outdoor unit and remote controller. Read "3. What to do before operation" on page 3.
- To protect the unit, turn on the main power switch 6 hours before operation.
- If the main power supply is turned off during operation, operation will restart automatically after the power turns back on again.

#### 7.1. Cooling, heating, fan only, and automatic operation (See figure 3 and figure 4.1)





- Changeover cannot be made with a remote controller whose display shows (change-over under centralized control).
- When the display (change-over under centralized control) flashes, refer to "7.4. Setting the master remote controller" on page 5.
- Automatic operation can be selected only for REM(H)Q + REYQ series.
- RXHQ series let you select fan only and heating operation.
- The fan may keep on running for about 1 minute after the heating operation stops.
- The air flow rate may adjust itself depending on the room temperature or the fan may stop immediately. This is not a malfunction.

---

## For systems without cool/heat changeover remote control switch (See figure 3)

---

- 1 Press the operation mode selector button several times and select the operation mode of your choice.

-  Cooling operation
-  Heating operation
-  Automatic operation
-  Fan only operation

**NOTE**  Automatic operation (for REM(H)Q + REYQ series only)  
In the automatic operation mode, cool/heat changeover is automatically conducted.

---





- 2 Press the on/off button.  
The operation lamp lights up and the system starts operation.

---

## For systems with cool/heat changeover remote control switch

---

- 1 Select operation mode with the cool/heat changeover remote control switch as follows:

-   Cooling operation (figure 4.1)
-   Heating operation (figure 4.2)
-  Fan only operation (figure 4.3)

- 2 Press the on/off button.  
The operation lamp lights up and the system starts operation.

### Adjustment

For programming temperature, fan speed and air flow direction, refer to the operation manual of the remote controller.

### Stopping the system

- 3 Press the on/off button once again.  
The operation lamp goes off and the system stops operation.

**NOTE**  Do not turn off power immediately after the unit stops, but wait for at least 5 minutes.

---

---

## Explanation of heating operation

---

It may take longer to reach the set temperature for general heating operation than for cooling operation.

The following operation is performed in order to prevent the heating capacity from dropping or cold air from blowing.

### Defrost operation (heat pump and heat recovery types only)

- In heating operation, freezing of the outdoor unit coil increases. Heating capability decreases and the system goes into defrost operation.
- The indoor unit fan stops and the remote controller displays .
- After maximum 10 minutes of defrost operation, the system returns to heating operation again.

### Hot start (heat pump and heat recovery types only)

- In order to prevent cold air from blowing out of an indoor unit at the start of heating operation, the indoor fan is automatically stopped. The display of the remote controller shows . It may take some time before the fan starts. This is not a malfunction.

**NOTE** 

- The heating capacity drops when the outside temperature falls. If this happens, use another heating device together with the unit. (When using together with appliances that produce open fire, ventilate the room constantly.)  
Do not place appliances that produce open fire in places exposed to the air flow from the unit or under the unit.
  - It takes some time to heat up the room from the time the unit is started since the unit uses a hot-air circulating system to heat the entire room.
  - If the hot air rises to the ceiling, leaving the area above the floor cold, we recommend that you use the circulator (the indoor fan for circulating air). Contact your dealer for details.
- 

## 7.2. Program dry operation

- The function of this program is to decrease the humidity in your room with minimal temperature decrease (minimal room cooling).
  - The micro computer automatically determines temperature and fan speed (cannot be set by the remote controller).
  - The system does not go into operation if the room temperature is low (<20°C).
- 

## For systems without cool/heat changeover remote control switch (See figure 5)

---

- 1 Press the operation mode selector button several times and select  (program dry operation).
- 2 Press the on/off button.  
The operation lamp lights up and the system starts operation.
- 3 Press the air flow direction adjust button. (Only for Double-flow, Multi-flow, Corner, Ceiling-suspended and Wall-mounted.) Refer to "7.3. Adjusting the air flow direction" on page 5 for details.

### Stopping the system

- 4 Press the on/off button once again.  
The operation lamp goes off and the system stops operation.

**NOTE**  Do not turn off power immediately after the unit stops, but wait for at least 5 minutes.

---

For systems with cool/heat changeover remote control switch (See figure 6)

- 1 Select cooling operation mode with the cool/heat changeover remote control switch.
- 2 Press the operation mode selector button several times and select  (program dry operation).
- 3 Press the on/off button.  
The operation lamp lights up and the system starts operation.
- 4 Press the air flow direction adjust button. (Only for Double-flow, Multi-flow, Corner, Ceiling-suspended and Wall-mounted.) Refer to "7.3. Adjusting the air flow direction" on page 5 for details.

#### Stopping the system

- 5 Press the on/off button once again.  
The operation lamp goes off and the system stops operation.

**NOTE**  Do not turn off power immediately after the unit stops, but wait for at least 5 minutes.

### 7.3. Adjusting the air flow direction

Refer to the operation manual of the remote controller.



Movement of the air flow flap (See figure 8)

- A Double-flow + Multi-flow units
- B Corner units
- C Ceiling-suspended units
- D Wall-mounted units

For the following conditions, a micro computer controls the air flow direction which may be different from the display.

COOLING	HEATING
<ul style="list-style-type: none"> <li>• When the room temperature is lower than the set temperature.</li> </ul>	<ul style="list-style-type: none"> <li>• When starting operation.</li> <li>• When the room temperature is higher than the set temperature.</li> <li>• At defrost operation.</li> </ul>
<ul style="list-style-type: none"> <li>• When operating continuously at horizontal air flow direction.</li> <li>• When continuous operation with downward air flow is performed at the time of cooling with a ceiling-suspended or a wall-mounted unit, the microcomputer may control the flow direction, and then the remote control indication also will change.</li> </ul>	

The air flow direction can be adjusted in one of the following ways.

- The air flow flap itself adjusts its position.
- The air flow direction can be fixed by the user.
- Automatic "" and desired position "".

**NOTE**  ■ The movable limit of the flap is changeable. Contact your dealer for details. (Only for Double-flow, Multi-flow, Corner, Ceiling-suspended and Wall-mounted.)

■ Avoid operating in the horizontal direction "". It may cause dew or dust to settle on the ceiling.

### 7.4. Setting the master remote controller

When the system is installed as shown in figure 9 (RXY(H)Q + RXYRQ + RXHQ + RXYSQ – the outdoor unit is connected to several indoor units) and figure 10 (REM(H)Q + REY(H)Q – one BS unit is connected to several indoor units), it is necessary to designate one of the remote controllers as the master remote controller.

- Only the master remote controller can select heating or cooling and in case of REM(H)Q + REY(H)Q units, automatic operation.
- The displays of slave remote controllers show  (change-over under centralized control) and slave remote controllers automatically follow the operation mode directed by the master remote controller.

However, it is possible to changeover to program dry with slave remote controllers if the system is in cooling operation set by the master remote controller.

#### How to designate the master remote controller

- 1 Press the operation mode selector button of the current master remote controller for 4 seconds.

The display showing  (change-over under centralized control) of all slave remote controllers connected to the same outdoor unit or BS unit flash.

- 2 Press the operation mode selector button of the controller that you wish to designate as the master remote controller. Then designation is completed. This remote controller is designated as the master remote controller and the display showing  (change-over under centralized control) vanishes.

The displays of other remote controllers show  (change-over under centralized control).

### 7.5. Precautions for group control system or two remote controller control system

This system provides two other control systems beside individual control (one remote controller controls one indoor unit) system. Confirm the following if your unit is of the following control system type.

- Group control system  
One remote controller controls up to 16 indoor units. All indoor units are equally set.
- Two remote controller control system  
Two remote controllers control one indoor unit (in case of group control system, one group of indoor units). The unit is individually operated.

**NOTE**  Contact your dealer in case of changing the combination or setting of group control and two remote controller control systems.

## 8. ENERGY SAVING AND OPTIMUM OPERATION

Observe the following precautions to ensure the system operates properly.

- Adjust the air outlet properly and avoid direct air flow to room inhabitants.
- Adjust the room temperature properly for a comfortable environment. Avoid excessive heating or cooling.
- Prevent direct sunlight from entering a room during cooling operation by using curtains or blinds.
- Ventilate often.  
Extended use requires special attention to ventilation.
- Keep doors and windows closed. If the doors and windows remain open, air will flow out of your room causing a decrease in the cooling or heating effect.
- Be careful not to cool or heat too much. To save energy, keep the temperature setting at a moderate level.

Recommended temperature setting	
For cooling	26~28°C
For heating	20~24°C

- Never place objects near the air inlet or the air outlet of the unit. It may cause deterioration in the effect or stop the operation.
- Turn off the main power supply switch to the unit when the unit is not used for longer periods of time. If the switch is on, it uses electricity. Before restarting the unit, turn on the main power supply switch 6 hours before operation to ensure smooth running. (Refer to "Maintenance" in the indoor unit manual.)
- When the display shows  (time to clean the air filter), ask a qualified service person to clean the filters. (Refer to "Maintenance" in the indoor unit manual.)
- Keep the indoor unit and remote control at least 1 m away from televisions, radios, stereos, and other similar equipment. Failing to do so may cause static or distorted pictures.
- Do not place items under the indoor unit which may be damaged by water.  
Condensation may form if the humidity is above 80% or if the drain outlet gets blocked.

## 9. MAINTENANCE



### Pay attention to the fan.

It is dangerous to inspect the unit while the fan is running. Be sure to turn off the main switch and to remove the fuses from the control circuit located in the outdoor unit.

### 9.1. Maintenance after a long stop period (e.g. at the beginning of the season)

- Check and remove everything that might be blocking inlet and outlet vents of indoor units and outdoor units.
- Clean air filters and casings of indoor units. Refer to the operation manual supplied with the indoor units for details on how to proceed and make sure to install cleaned air filters back in the same position.
- Turn on the power at least 6 hours before operating the unit in order to ensure smoother operation. As soon as the power is turned on, the remote controller displays appear.

### 9.2. Maintenance before a long stop period (e.g. at the end of the season)



- Let the indoor units run in fan only operation for about half a day in order to dry the interior of the units. Refer to "7.1. Cooling, heating, fan only, and automatic operation" on page 3 for details on fan only operation.
- Turn off the power. The remote controller displays disappear.
- Clean air filters and casings of indoor units. Refer to the operation manual supplied with the indoor units for details on how to proceed and make sure to install cleaned air filters back in the same position.

## 10. FOLLOWING SYMPTOMS ARE NOT AIR CONDITIONER TROUBLES

### Symptom 1: The system does not operate

- The air conditioner does not start immediately after the ON/OFF button on the remote controller is pushed.  
If the operation lamp lights, the system is in normal condition. To prevent overloading of the compressor motor, the air conditioner starts 5 minutes after it is turned ON again in case it was turned OFF just before. The same starting delay occurs after the operation mode selector button was used.
- If "Centralized Control" is displayed on the remote control and pressing the operation button causes the display to blink for a few seconds.  
This indicates that the central device is controlling the unit. The blinking display indicates that the remote control cannot be used.
- The system does not start immediately after the power supply is turned on.  
Wait one minute until the micro computer is prepared for operation.

### Symptom 2: Cool/Heat cannot be changed over

- When the display shows "" (change-over under centralized control), it shows that this is a slave remote controller.
- When the cool/heat changeover remote control switch is installed and the display shows "" (change-over under centralized control).  
This is because cool/heat changeover is controlled by the cool/heat changeover remote control switch. Ask your dealer where the remote control switch is installed.

### Symptom 3: Fan operation is possible, but cooling and heating do not work.

- Immediately after the power is turned on.  
The micro computer is getting ready to operate. Wait 10 minutes.

### Symptom 4: The fan strength does not correspond to the setting.

- The fan strength does no change even if the fan strength adjustment button is pressed.  
During heating operation, when the room temperature reaches the set temperature, the outdoor unit goes off and the indoor unit changes to whisper fan strength.  
This is to prevent cold air blowing directly on occupants of the room.  
The fan strength will not change even if the button is changed, when another indoor unit is in heating operation.

### Symptom 5: The fan direction does not correspond to the setting

- The fan direction does not correspond to the remote control display. The fan direction does not swing.  
This is because the unit is being controlled by the micro computer.



### Symptom 6: White mist comes out of a unit

#### Symptom 6.1: Indoor unit

- When humidity is high during cooling operation  
If the interior of an indoor unit is extremely contaminated, the temperature distribution inside a room becomes uneven. It is necessary to clean the interior of the indoor unit. Ask your dealer for details on cleaning the unit. This operation requires a qualified service person.
- Immediately after the cooling operation stops and if the room temperature and humidity are low.  
This is because warm refrigerant gas flows back into the indoor unit and generates steam.

#### Symptom 6.2: Indoor unit, outdoor unit

- When the system is changed over to heating operation after defrost operation  
Moisture generated by defrost becomes steam and is exhausted.

### Symptom 7: The remote controller display reads "U4" or "U5" and stops, but then restarts after a few minutes

- This is because the remote control is intercepting noise from electric appliances other than the air conditioner. This prevents communication between the units, causing them to stop. Operation automatically restarts when the noise ceases.

### Symptom 8: Noise of air conditioners

#### Symptom 8.1: Indoor unit

- A "zeen" sound is heard immediately after the power supply is turned on.  
The electronic expansion valve inside an indoor unit starts working and makes the noise. Its volume will reduce in about one minute.
- A continuous low "shah" sound is heard when the system is in cooling operation or at a stop  
When the drain pump (optional accessories) is in operation, this noise is heard.
- A "pishi-pishi" squeaking sound is heard when the system stops after heating operation.  
Expansion and contraction of plastic parts caused by temperature change make this noise.
- A low "sah", "choro-choro" sound is heard while the indoor unit is stopped.  
When the other indoor unit is in operation, this noise is heard. In order to prevent oil and refrigerant from remaining in the system, a small amount of refrigerant is kept flowing.

#### Symptom 8.2: Indoor unit, outdoor unit

- A continuous low hissing sound is heard when the system is in cooling or defrost operation.  
This is the sound of refrigerant gas flowing through both indoor and outdoor units.
- A hissing sound which is heard at the start or immediately after stopping operation or defrost operation.  
This is the noise of refrigerant caused by flow stop or flow change.

#### Symptom 8.3: Outdoor unit

- When the tone of operating noise changes.  
This noise is caused by the change of frequency.

### Symptom 9: Dust comes out of the unit

- When the unit is used for the first time in a long time.  
This is because dust has gotten into the unit.

### Symptom 10: The units can give off odours

- The unit can absorb the smell of rooms, furniture, cigarettes, etc., and then emit it again.

### Symptom 11: The outdoor unit fan does not spin.

- During operation.  
The speed of the fan is controlled in order to optimize product operation.

### Symptom 12: The display shows "E8".

- This is the case immediately after the main power supply switch is turned on and means that the remote controller is in normal condition. This continues for one minute.

### Symptom 13: The compressor in the outdoor unit does not stop after a short heating operation

- This is to prevent oil and refrigerant from remaining in the compressor. The unit will stop after 5 to 10 minutes.

### Symptom 14: The inside of an outdoor unit is warm even when the unit has stopped

- This is because the crankcase heater is warming the compressor so that the compressor can start smoothly.

### Symptom 15: Hot air can be felt when the indoor unit is stopped

- Several different indoor units are being run on the same system. When another unit is running, some refrigerant will still flow through the unit.

## 11. TROUBLESHOOTING

If one of the following malfunctions occur, take the measures shown below and contact your dealer.



### WARNING

**Stop operation and shut off the power if anything unusual occurs (burning smells, etc.)**

Leaving the unit running under such circumstances may cause breakage, electric shock or fire.

Contact your dealer.

The system must be repaired by a qualified service person.

- If a safety device such as a fuse, a breaker or an earth leakage breaker frequently actuates or the ON/OFF switch does not properly work.  
Measure: Turn off the main power switch.
- If water leaks from the unit  
Measure: Stop the operation.
- The operation switch does not work well.  
Measure: Turn off the power.
- If the display  TEST, the unit number and the operation lamp flash and the malfunction code appears. (See figure 7)

- 1 Inspection display
- 2 Indoor unit number in which a malfunction occurs
- 3 Operation lamp
- 4 Malfunction code

Measure: Notify your dealer and report the malfunction code.

If the system does not properly operate except for the above mentioned cases and none of the above mentioned malfunctions is evident, investigate the system according to the following procedures.

### 1 If the system does not operate at all

- Check if there is no power failure.  
Wait until power is restored. If power failure occurs during operation, the system automatically restarts immediately after the power supply is recovered.
- Check if no fuse has blown or breaker has worked. Change the fuse or reset the breaker if necessary.

**2 If the system goes into fan only operation, but as soon as it goes into heating or cooling operation, the system stops**

- Check if air inlet or outlet of outdoor or indoor unit is not blocked by obstacles. Remove any obstacle and make it well-ventilated.
- Check if the remote controller display shows "  " (time to clean the air filter). (Refer to "Maintenance" in the indoor unit manual.)

**3 The system operates but cooling or heating is insufficient**

- Check if air inlet or outlet of outdoor or indoor unit is not blocked by obstacles.
- Remove any obstacle and make it well-ventilated.
- Check if the air filter is not clogged. (Refer to "Maintenance" in the indoor unit manual.)
- Check the temperature setting.
- Check the fan speed setting on your remote controller.
- Check for open doors or windows. Shut doors and windows to prevent wind from coming in.
- Check if there are too many occupants in the room during cooling operation
- Check if the heat source of the room is excessive.
- Check if direct sunlight enters the room. Use curtains or blinds.
- Check if the air flow angle is proper.

If after checking all above items, it is impossible to fix the problem yourself, contact your dealer and state the symptoms, the complete model name of the air conditioner (with manufacturing number if possible) and the installation date (possibly listed on the warranty card).

## 12. AFTER-SALES SERVICE AND WARRANTY

### Warranty period

- This product includes a warranty card that was filled out by the dealer at the time of installation. The completed card was checked by the customer and stored carefully.
- If repairs to the air conditioner are necessary within the warranty period, contact your dealer and keep the warranty card at hand.

### 12.1. After-sales service

- Recommendations for maintenance and inspection  
 Since dust collects when using the unit for several years, performance of the unit will deteriorate to some extent. As taking apart and cleaning interiors of units requires technical expertise and in order to ensure the best possible maintenance of your units, we recommend to enter into a maintenance and inspection contract on top of normal maintenance activities. Our network of dealers has access to a permanent stock of essential components in order to keep your air conditioner in operation as long as possible. Contact your dealer for more information.
- When asking your dealer for an intervention, always state:
  - the complete model name of the air conditioner
  - the manufacturing number (stated on the nameplate of the unit)
  - the installation date
  - the symptoms or malfunction, and details of the defect.



### WARNING

- Do not modify, disassemble, remove, reinstall or repair the unit yourself as incorrect dismantling or installation may cause an electric shock or fire. Contact your dealer.
- In case of accidental refrigerant leaks, make sure there are no naked flames. The refrigerant itself is entirely safe, non-toxic and non-combustible, but it will generate toxic gas when it accidentally leaks into a room where combustible air from fan heaters, gas cookers, etc. ... is present. Always have qualified service personnel confirm that the point of leakage has been repaired or corrected before resuming operation.

- Recommended inspection and maintenance cycles

Be aware that the mentioned maintenance and replacement cycles do not relate to the warranty period of the components.

**Table 1:** "Inspection Cycle" and "Maintenance Cycle" list

Component	Inspection cycle	Maintenance cycle (replacements and/or repairs)
Electric motor	1 year	20,000 hours
PCB		25,000 hours
Heat exchanger		5 years
Sensor (thermistor, etc.)		5 years
Remote controller and switches		25,000 hours
Drain pan		8 years
Expansion valve		20,000 hours
Electromagnetic valve		20,000 hours

Table 1 assumes the following conditions of use:

1. Normal use without frequent starting and stopping of the unit. Depending on the model, we recommend not starting and stopping the machine more than 6 times/hour.
2. Operation of the unit is assumed to be 10 hours/day and 2,500 hours/year.



### NOTE

1. Table 1 indicates main components. Refer to your maintenance and inspection contract for more details.
2. Table 1 indicates recommended intervals of maintenance cycles. However, in order to keep the unit operational as long as possible, maintenance work may be required sooner. Recommended intervals can be used for appropriate maintenance design in terms of budgetting maintenance and inspection fees. Depending on the content of the maintenance and inspection contract, inspection and maintenance cycles may in reality be shorter than listed.

## 12.2. Shortening of "maintenance cycle" and "replacement cycle" needs to be considered in following situations

- The unit is used in locations where:
  1. heat and humidity fluctuate out of the ordinary
  2. power fluctuation is high (voltage, frequency, wave distortion, etc.)  
(The unit cannot be used if power fluctuation is outside the allowable range.)
  3. bumps and vibrations are frequent
  4. dust, salt, harmful gas or oil mist such as sulfurous acid and hydrogen sulfide may be present in the air
  5. the machine is started and stopped frequently or operation time is long (sites with 24 hour air-conditioning).
- Recommended replacement cycle of wear parts

**Table 2:** "Replacement Cycle" list

Component	Inspection cycle	Maintenance cycle (replacements and/or repairs)
Air filter	1 year	5 years
High efficiency filter (Optional)		1 year
Fuse		10 years
Crankcase heater		8 years

**NOTE**



1. Table 2 indicates main components. Refer to your maintenance and inspection contract for more details.
2. Table 2 indicates recommended intervals of replacement cycles. However, in order to keep the unit operational as long as possible, maintenance work may be required sooner. Recommended intervals can be used for appropriate maintenance design in terms of budgetting maintenance and inspection fees.

Contact your dealer for details.

**NOTE**



Damage due to taking apart or cleaning interiors of units by anyone other than our authorised dealers may not be included in the warranty.

- Moving and discarding the unit
  - Contact your dealer for removing and reinstalling the total unit. Moving units requires technical expertise.
  - This unit uses hydrofluorocarbon. Contact your dealer when discarding this unit. It is required by law to collect, transport and discard the refrigerant in accordance with the "hydrofluorocarbon collection and destruction" regulations.

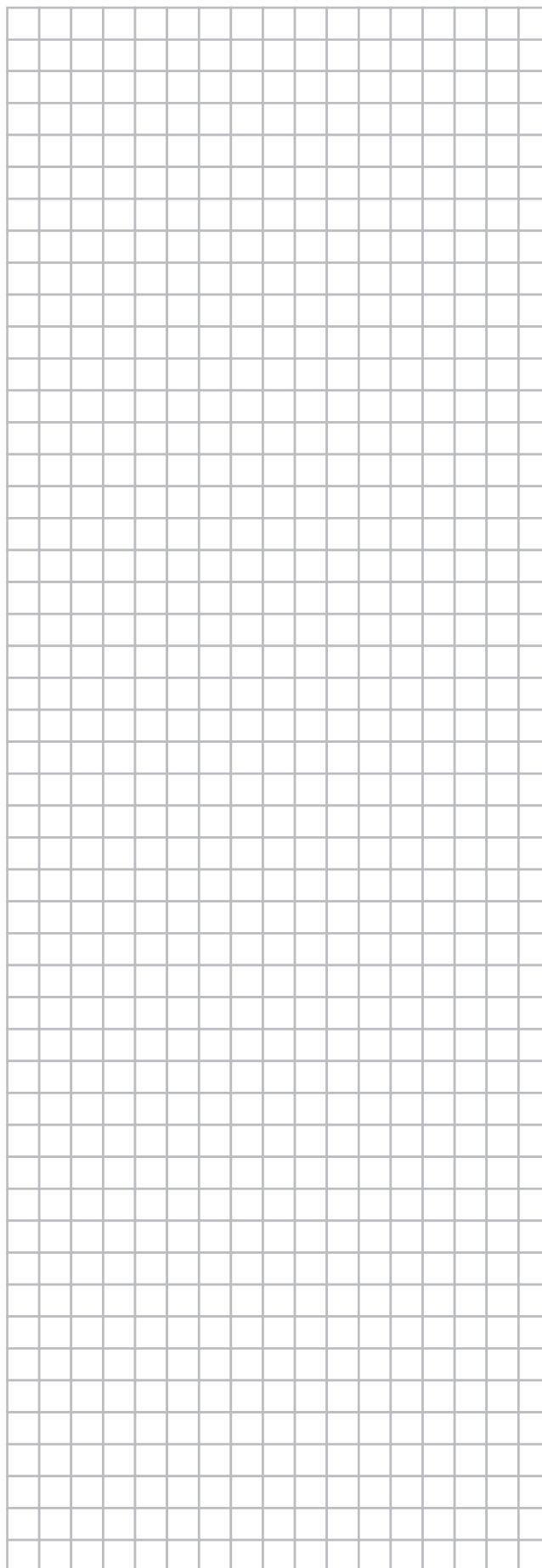

**ERC**

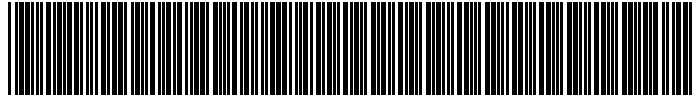

\*4P482259-1 0000000S\*

Copyright 2017 Daikin

**DAIKIN EUROPE N.V.**

Zandvoordestraat 300, B-8400 Oostende, Belgium

4P482259-1 2017.03